



Product Catalog

Canadian Fuses & Holders

 **COOPER** Circuit Protection





General Catalog Contents

Page

Canadian Fuses & Accessories	
Standard Code Fuses 250V & 600V	
	KOS/KON/PONC93
	CDSC/CDNC93
Fuse Holders	
	CAMaster HRC Fuse Holder96
	SAFEloc HRCI-CB Fuse Holder99



**Standard Dimension Fuses with 10kA Minimum Interrupting Rating;
CSA Certified to C22.2 No. 59.1**

Time-Delay

Volts	Ref.	Amp Ratings	Ctn. Qty.
600Vac	CDSC*	Below 10A use ECSR 10, 12, 15, 20, 25, 30, 35, 40, 45, 50, 60	10
		70, 80, 90, 100	5
		110, 125, 150, 175, 200, 225, 250, 300, 350, 400, 450, 500, 600	1
250Vac	CDNC*	Below 10A use ECNR 10, 12, 15, 20, 25, 30, 35, 40, 45, 50, 60	10
		70, 80, 90, 100	5
		110, 125, 150, 175, 200, 225, 250, 300, 350, 400, 450, 500, 600	1

One-Time

Volts	Ref.	Amp Ratings	Ctn. Qty.
600Vac	KOS**	1, 2, 3, 4, 5, 6, 7, 8, 10, 12, 15, 20, 25, 30 35, 40, 45, 50, 60	10
		70, 80, 90, 100	5
		110, 125, 150, 175, 200, 225, 250, 300, 350, 400, 450, 500, 600	1
250Vac	KON**	1, 2, 3, 4, 5, 6, 7, 8, 10, 12	10
	PONC***	15, 20, 25, 30, 35, 40, 45, 50, 60 (CSA 'P')	
	KON	70, 80, 90, 100 110, 125, 150, 175, 200, 225, 250, 300, 350, 400, 450, 500, 600	5 1

Dimensions - in (mm)

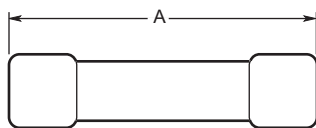

Ferrule Design—1 through 60 Amps

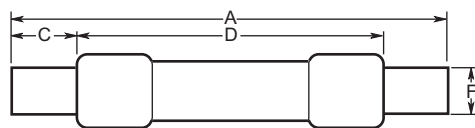

Knife Blade—70 through 600 Amps



Volts	Catalog Number	Amps	Max. A	Min. B	Min. C	D	E	F	
250Vac	CDNC* PONC*** KON*	1-30	2.0 (50.8)	0.56 (14.3)	-	-	-	-	
		35-60	3.0 (76.2)	0.81 (20.6)	-	-	-	-	
		70-100	5.88 (149.4)	-	-	1.0 (25.4)	-	0.13 (3.2)	0.75 (19.1)
		110-200	7.3 (185.4)	-	-	1.38 (34.9)	4.13 (104.8)	0.19 (4.8)	1.13 (28.6)
		225-400	8.63 (219.2)	-	-	1.88 (47.6)	4.63 (117.5)	0.25 (6.4)	1.63 (41.3)
		450-600	10.38 (263.7)	-	-	2.25 (57.2)	5.19 (131.8)	0.25 (6.4)	2 (50.8)
600Vac	CDSC* KOS*	1-30	5.0 (127.0)	0.81 (20.6)	-	-	-	-	
		35-60	5.5 (139.7)	1.06 (27.0)	-	-	-	-	
		70-100	7.88 (200.2)	-	-	1.0 (25.4)	-	0.13 (3.2)	0.75 (19.1)
		110-200	9.63 (244.6)	-	-	1.38 (34.9)	6.13 (115.6)	0.19 (4.8)	1.13 (28.6)
		225-400	11.63 (295.4)	-	-	1.88 (47.6)	7.13 (118.1)	0.25 (6.4)	1.63 (41.3)
		450-600	13.38 (339.9)	-	-	2.25 (57.2)	8.19 (208.0)	0.25 (6.4)	2 (50.8)

*CDSC & CDNC are CSA certified Type "D".

** KON 1-12A and KOS 1-60A are not CSA Certified.

*** PONC are CSA certified Type "P".

Average Time-Current Curves

Cat. No. KON/PONC 250Vac

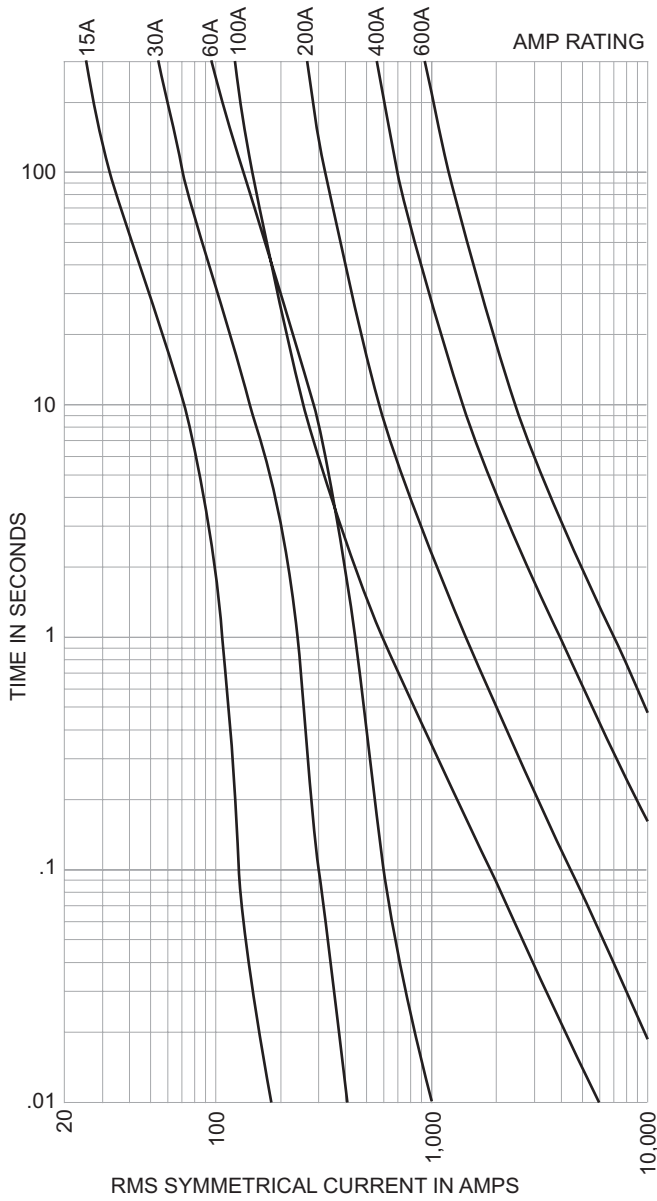

Cat. No. KOS 600Vac

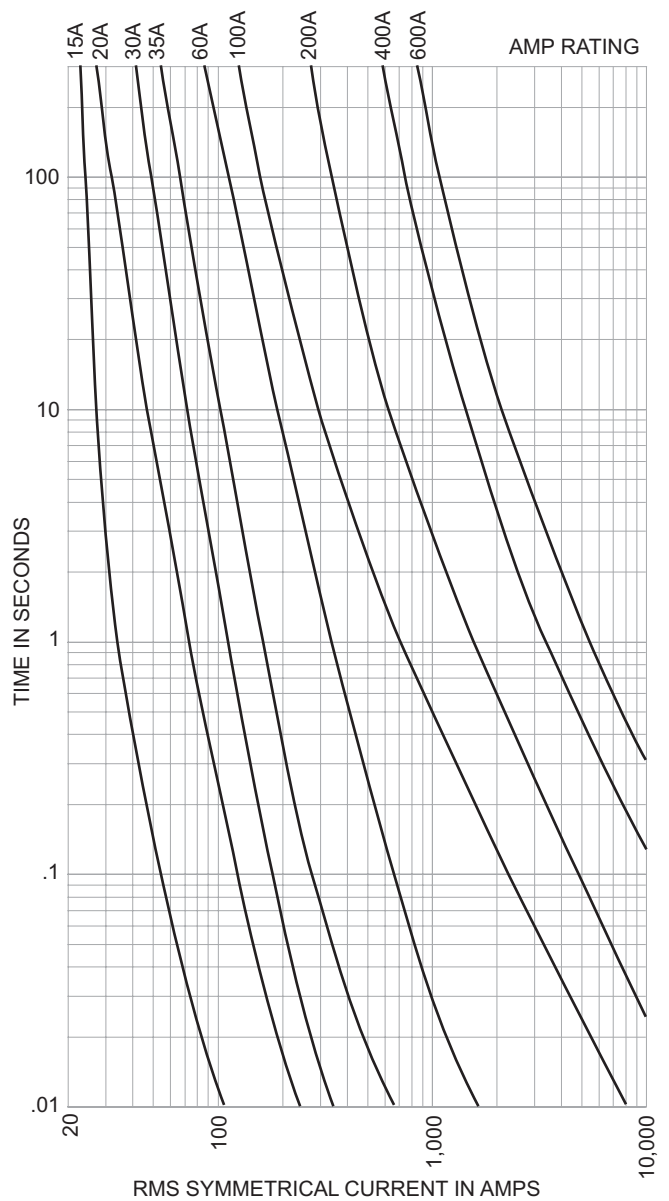

Average Time-Current Curves

Cat. No. CDNC 250Vac

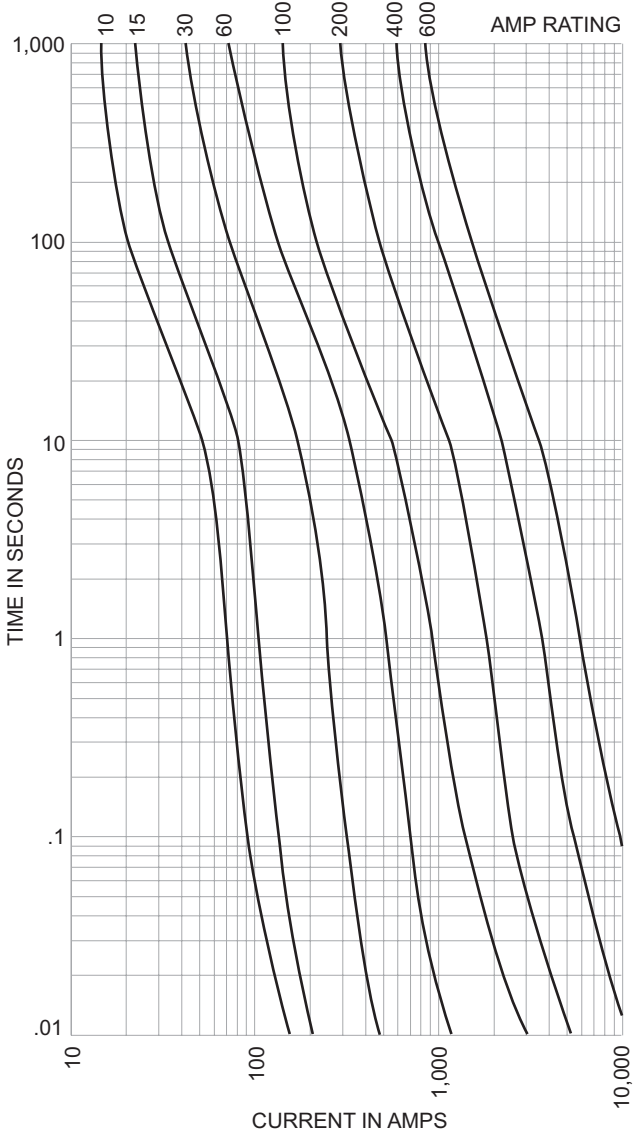

Cat. No. CDSC 600Vac

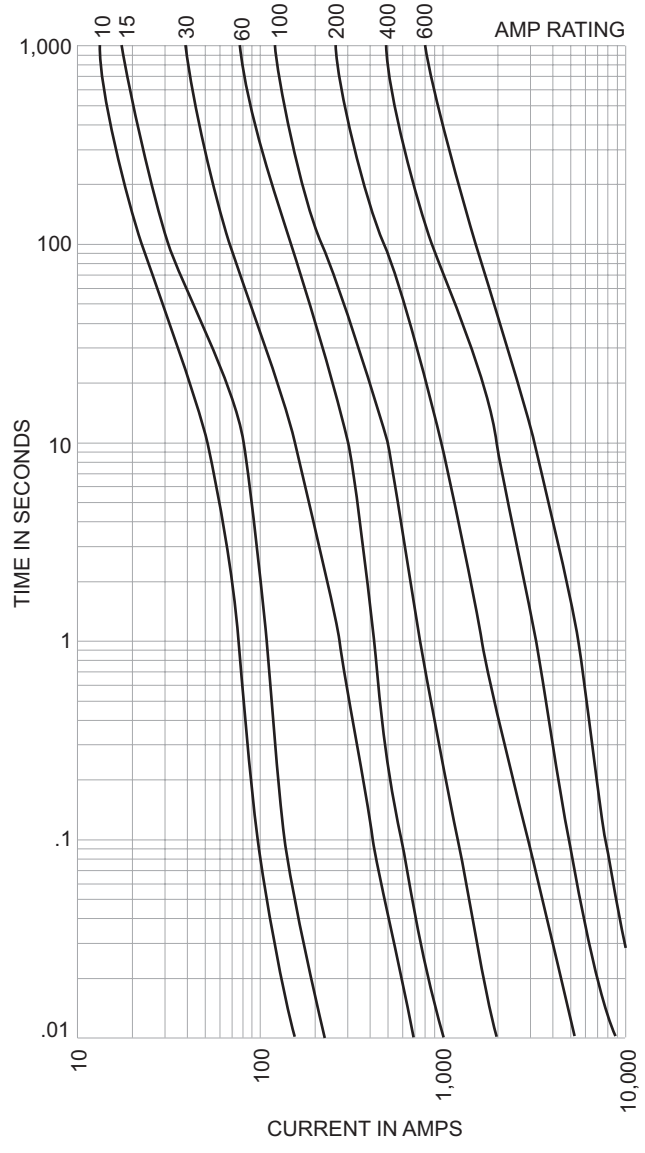

UL/CSA Fuses
Current Limiting

UL/CSA Fuses
General Purpose

Special
Purpose Fuses

Canadian
Fuses & Holders

Medium
Voltage Fuses

Fuse Blocks,
Holders & Misc.

Application
Section



Figure 1

Range: 30 (miniature), 30, 60, and 100 Amp at 600Vac

A range of fully shrouded HRC fuse holders having an advanced design. They incorporate a high level of innovation, with enhanced performance characteristics and comply with the requirements of: CSA C22.2 No. 39 as well as IEC 60269 and BS88 Standards.

Unique Cam Action

The fuse carriers are fitted with a cam for ease of removal from the fuse bases allowing significantly improved contact pressure between fuse carrier and fuse base contacts, with a corresponding enhanced electrical performance level. This design overcomes a major problem of all existing dead front style fuse holders manufactured worldwide, which have to compromise between difficulties of fuse carrier removal from base and contact pressure achieved.

Lockable Safety Carriers

A range of lockable safety carriers for the CAMaster fuse holder (Cat ref: LSC), are available. This distinct feature ensures isolation can be achieved allowing maintenance to be carried out in safety.

Fixing Torque and Cable Size

Ref	Fuse Fixing Tightening Torques	Max Cable Size
CM20CF	1.5N·m	#2
CM30CF	1.5N·m	#2
CM60CF	2.0N·m	2/0
CM100CF	2.0N·m	2/0

Catalog Numbers

Amps	Mounting	Edison Catalog Numbers
30	Front	CM20CF
	Front/2-pole	2xCM20CF + GLP
	Back	CM20CF + 2 off 20BS
	Front/Back	CM20CF _ 1 off 20BS
30	Front	CM30CF
	Back	CM30CF + 2 off 30BS
	Front/Back	CM30CF + 1 off 30BS
60	Front	CM60CF
	Back	CM60CF + 2 of 60/100BS
	Front/Back	CM60CF + 1 of 60/100BS
100*	Front	CM100CF
	Back	CM100CF + 2 of 60/100BS
	Front/Back	CM100CF + 1 or 60/100BS

*Uses compact Edison fuses.

CAMaster Ratings

Rating	Details	Reference	Fuse Accommodated
30 Amp	For HRCI-CA Applications	CM20CF	--CIF21
30 Amp 60 Amp 100 Amp	For HRCII Applications	CM30CF CM60CF CM100CF	---H07C ---K07C ---K07CR

Accessories for CAMaster Units

Rating	Details	Reference	Fuse Accommodated
30 Amp 30 Amp 60/100 Amp	Back Stud	20BS 30BS 60/100BS	For CM20CF For CM30CF For CM60/100CF
All	Ganging Link Kit	GLP	For 3 Pole
All	660V Neon Indicator	NI-660	-
30 Amp 30 Amp 60/100 Amp All	Security Carrier with Clip. Clip Only	20LSC 30LSC 60/100LSC CMCS	For CM20CF For CM30CF For CM60/100CF For all sizes
30 Amp 30 Amp 60/100 Amp	Solid Link	20CML 32CML 63/100 CML	For CM20CF For CM30CF For CM60/100CF

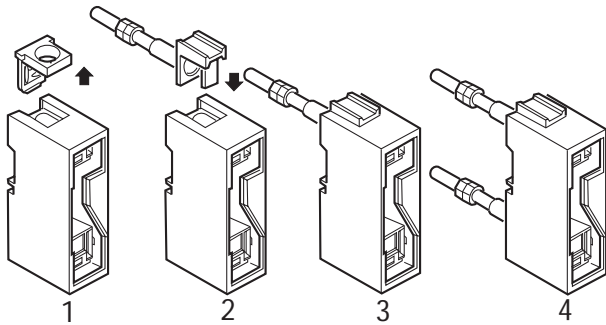

Figure 2. Unique Conversion Capability

Unique Conversion Capability

The standard fuse holders can be readily converted from front connection to front/back stud and double-back stud connection types at the point of use. This is achieved with a unique back stud accessory and the use of a screwdriver. See conversion sequence in Fig. 2. Steps 1, 2 and 3 show removal of ferrule end and insertion of back stud accessory to give the front/back stud connection type. This sequence repeated at the opposite end gives the double-back stud connection type shown in step 4.

Unique Cable Termination

The fuse holder's unique cable terminations are designed for user convenience and to ensure long-term reliability. They incorporate stainless steel saddles and hardened termination screws, maintaining permanent cable clamping to profiled contact plates. The main electrical contact path between the cable and fuse link tag is shown highlighted. This permits the use of high tightening torques without damage to cables or threads and provides resistance to high cable pull out forces. (See Fig. 3.) The fuse holders are supplied with the hardened termination screws backed out ready for cable insertion, saving installation time.

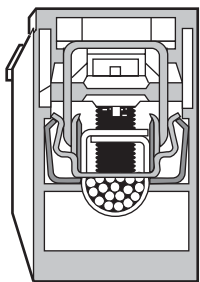

Figure 3. Unique Cable Termination

Hinged Captive Screws

The fuse fixing screws to fuse carrier are held in captive hinges providing ease of fixing and preventing loss during installation. (See Fig. 4.)

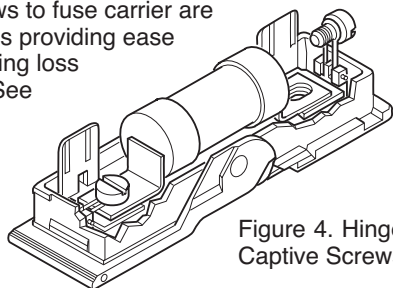

Figure 4. Hinged Captive Screws

Two/Three Pole Ganging

The unique design of the carriers allows ganging to be readily achieved by the use of standard accessories. This provides improved safety related to isolation and protection of 2-Pole and 3-Pole electrical circuits by ensuring that the correctly related poles are removed at the same time. (See Fig. 5.)

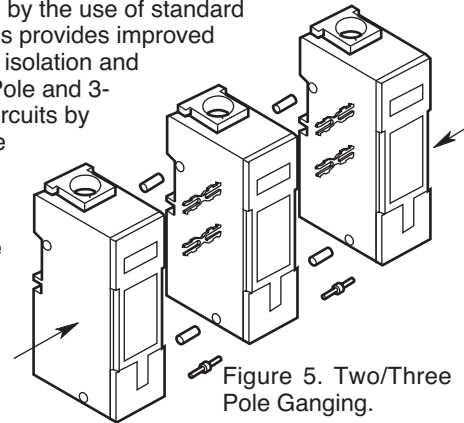

Figure 5. Two/Three Pole Ganging.

Dual Mounting Capability

The design as standard provides both bolted panel and DIN rail mounting features. The DIN rail mounting facility for each of the various dimensioned ratings is so designed as to give equal height and depth above the DIN rail.

Hinged Internal Shields

Non-removable full shrouding of live parts within the fuse base is provided by the use of hinged shields. The positive captive nature of these ensures that they cannot be omitted during installation and are so designed that insertion of the fuse carrier can only be made with them correctly positioned.

Neon Indicator

Neon clip-in indicator accessories are available providing clear location and status of fuses which have opened. (See Fig. 6.)

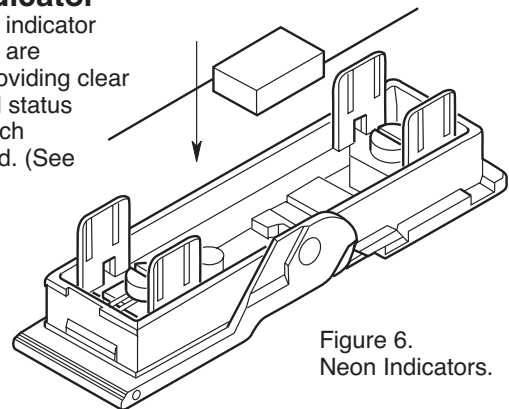

Figure 6. Neon Indicators.

Circuit Identification

The fuse carrier has a marking label for ease of circuit identification.

Strip Length Marking

The length of cable insulation that should be stripped off is shown on the side of the fuse base.

UL/CSA Fuses
Current Limiting

UL/CSA Fuses
General Purpose

Special
Purpose Fuses

Canadian
Fuses & Holders

Medium
Voltage Fuses

Fuse Blocks,
Holders & Misc.

Application
Section

Dimensions - in (mm)

Standard Front Connected Unit

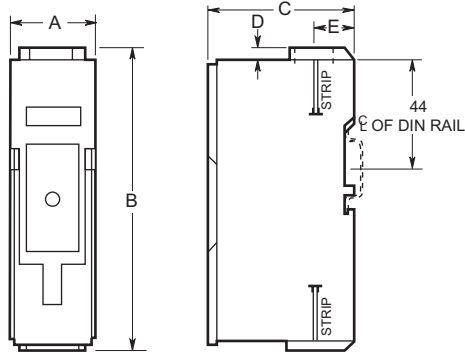

Front/Back Stud and Double Back Stud Connected Units

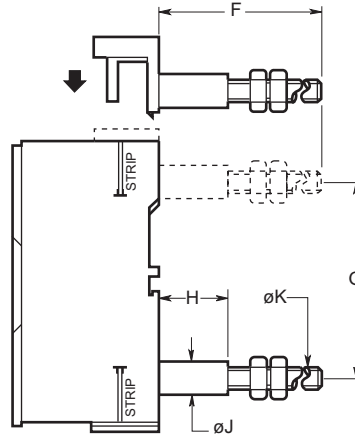

Rating Amps	Catalog Number	Category	Dimensions - in (mm)									
			A	B	C	D	E	F	G	H	J	K
30	CM20CF	HRCI-CA	1.0 (25.4)	3.69 (93.7)	2.36 (60)	0.13 (3.2)	0.64 (17.5)	2.60 (66)	2.29 (58)	1.13 (28.6)	0.47 (11.9)	M6
30	CM30CF	HRCII-C	1.25 (31.8)	4.63 (117.5)	2.36 (60)	0.13 (3.2)	0.69 (17.5)	2.60 (66)	2.92 (74)	1.13 (28.6)	0.47 (11.9)	M6
60	CM60CF	HRCII-C	1.40 (35.6)	4.93 (125)	2.36 (60)	0.19 (4.75)	0.65 (16.4)	3.41 (86.5)	3.14 (79.8)	1.13 (28.6)	0.47 (11.9)	M8
100	CM100CF	HRCII-MISC	1.40 (35.6)	4.93 (125)	2.36 (60)	0.19 (4.75)	0.65 (16.4)	3.41 (86.5)	3.14 (79.8)	1.13 (28.6)	0.47 (11.9)	M8

Panel Drilling Plans, Viewed from Front of Panel

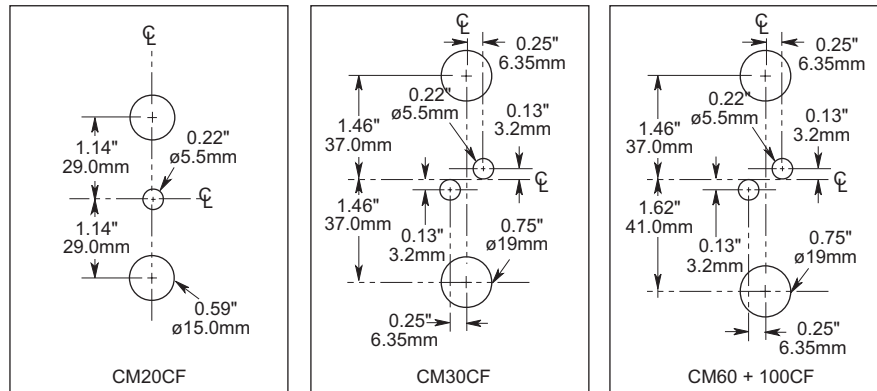



For use with HRCI-CB Fuses. Suitable for Bolted Panel Mounting or DIN Rail Mounting.

Description

SAFEloc fuse holders provide a simple range designed to accommodate the compact range of offset blade fuse to CSA C22.2 No. 106, HRCI-CB. The combination offers significant savings in volume and cost as well as a reduction in fitting time and power loss.

Features

The fuse holders incorporate a unique slide/snap action carrier which eliminates the need for fuse carrier contacts. This provides positive, stress free fitting of fuse and locks the fuse in position ensuring safe insertion and withdrawal from the base. The resulting direct contact between fuse blades and the plated base contacts provides lower watts loss and increased reliability. The base contacts are fully shrouded to protect personnel from direct contact electric shock. The shrouds utilize simple slide/snap action allowing access to the contact terminal screws. They are semi-captive within the base, reducing the risk of loss during cabling. The fuse base, which consists of glass filled, high impact resistant thermoplastic polyester, incorporates a direct 35mm DIN rail mounting facility as well as single screw fixing.

Tightening Torque

To avoid a heat build up it is most important the cable terminal screws are screwed in tight and are holding the cable firmly. A tightening torque of 2.5 to 2.8 Newton meters (N·m) or 22 to 25lb-in is recommended.

Catalog Numbers

For use with HRCI-CB Fuses			
Rating	Connection	Edison Catalog Numbers	Fuse Accommodated
30 Amp	Front	C30F	CIF06
	Back	C30BS	
	Front-Back	C30FBS	
60 Amp	Front	C60F	EK
	Back	C60BS	
	Front-Back	C60FBS	

SAFEloc fuse holders provide an easy method of protecting a wide range of electrical equipment such as lighting, heating, motor and control equipment circuits, and offer significant savings on volume, cost, fitting time and power loss.

Dimensions - in (mm)

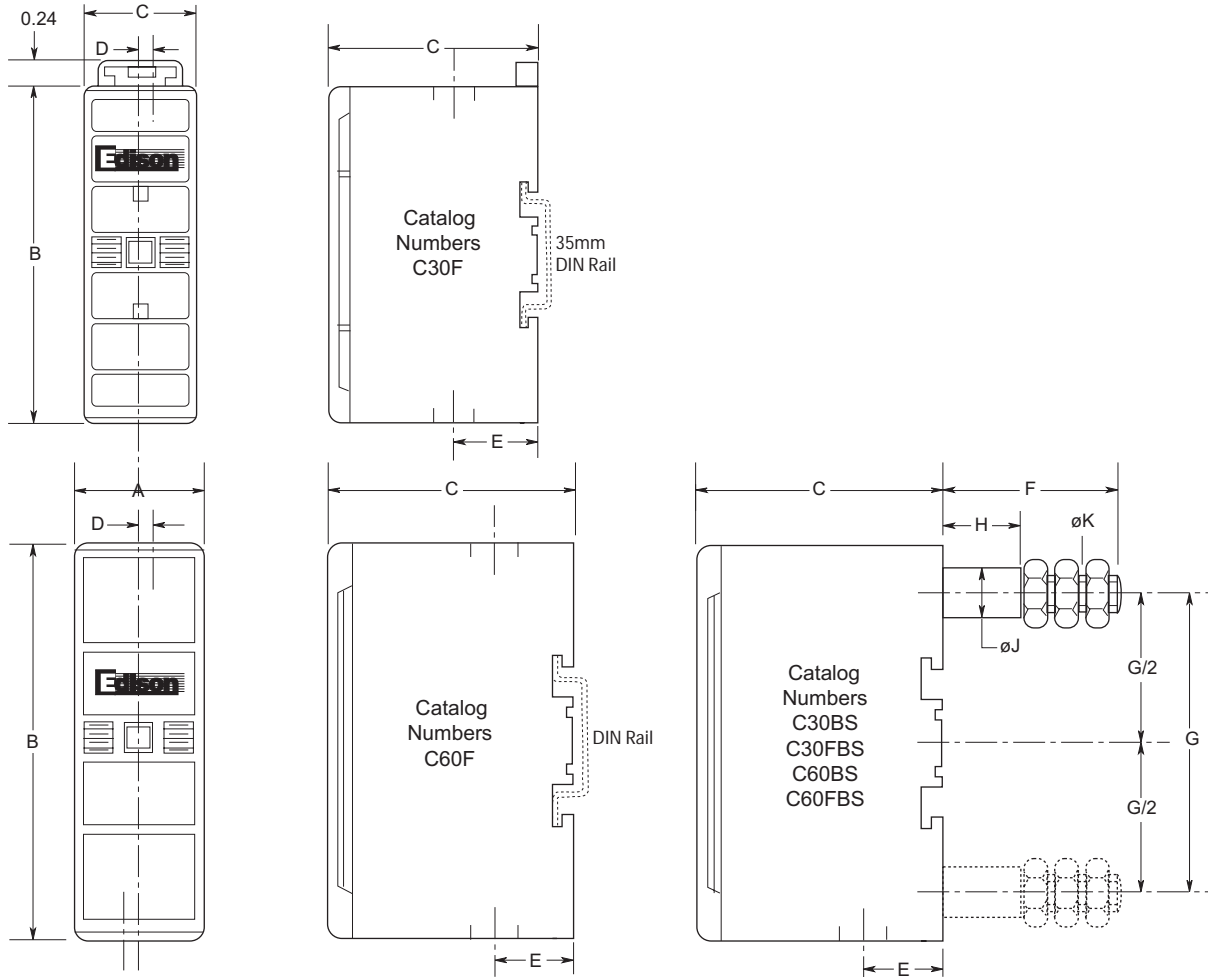

Dimensions - in (mm)

Amps	Series Number	Max. Cable mm ²	A	B	C	D	E	F	G	H	J	K
30	C30	16	1.0 (25.4)	3.0 (76.2)	1.83 (46.5)	0.09 (2.3)	0.63 (16.0)	1.54 (39.2)	2.27 (57.7)	0.67 (17.0)	0.38 (9.7)	M6
60	C60	35	1.15 (29.1)	3.55 (90.0)	2.18 (55.0)	0.13 (3.3)	0.70 (17.7)	1.54 (39.2)	2.68 (67.9)	0.69 (17.5)	0.43 (11.0)	M8

